

MORE FROM WOOD.

E EGGER

Egger Timber

**Green, kiln dried or planed –
to meet the highest demands.**



FOR THE WORLD

Contents

1	The EGGER sawmill	5
	Back to the roots	6
	The fully integrated plant	7
	Always one step ahead thanks to the latest technology	8
2	Application areas	13
	Wood construction	14
	Industrial production	15
3	Sawmill products	17
	General information	18
	Product parameters	19
	Squared timbers	21
	Planks	21
	Boards	21
4	Handling	23
	Storage and packaging	24
	Disposal	24
5	Quality and service	27
	Quality	29



1 **The EGGER sawmill**

Deeply rooted in tradition.
Grown through innovation.

There is a lot of technology behind sawmill products. Thanks to a flexible profile chipping line, Wood-X, Viscan, Goldeneye, and the fastest bundling machine in Europe, the sawmill provides a comprehensive, verified and certified range of products.

Back to the roots – How it all began.



Everything started with the sawmill in St. Johann i.T. (AT).

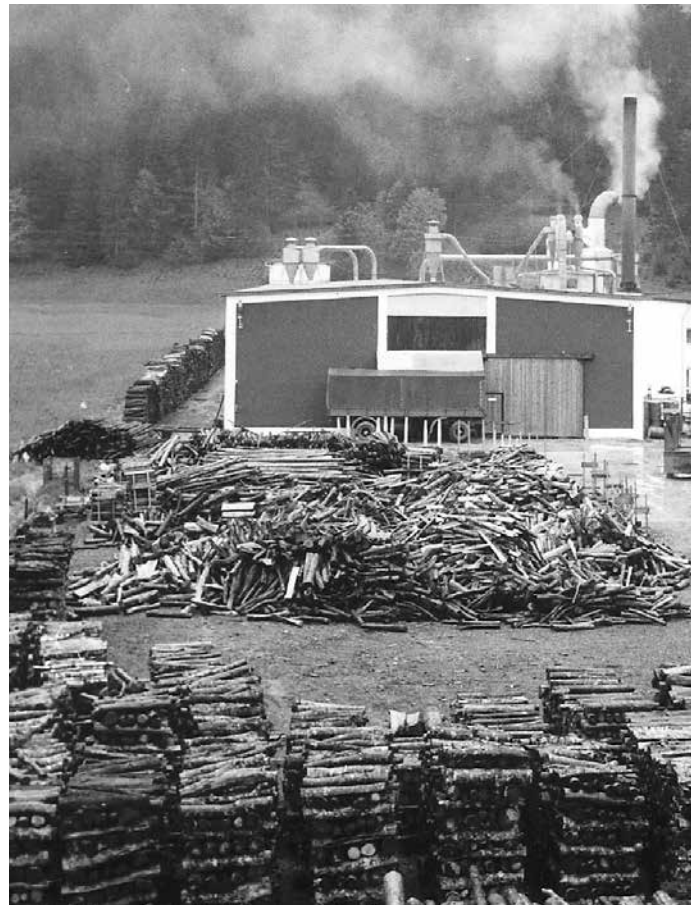

The chipboard plant in St. Johann i.T. (AT), 1961.

The Brilon sawmill was built in 2008 in the heart of Europe. EGGER, the wood-based materials company, returned to its roots. More than half a century ago, Fritz Egger Senior laid the foundation for a remarkable development by setting up a sawmill at St. Johann in Tirol (AT). In 1961 the plant produced its first chipboard, and since then EGGER has grown into one of the leading producers of wood-based materials in Europe.

The huge forests surrounding Brilon offer the perfect location for the sawmill. In the Hochsauerland region, up to 70% of the area is covered with extensive forests. This means that Brilon and its surroundings are one of the most densely forested regions in Germany. As a fully integrated plant with a direct link to the existing production of wood-based materials, the sawmill can benefit from numerous synergies.



The Brilon sawmill covers a total surface of approximately 20 hectares.

The fully integrated plant

The sawmill covers an area of 925 × 215 metres, and is located next to EGGER’s wood-based materials production site. This means that EGGER’s plant in Brilon has a surface of 570,000 m² and includes a rail network that is approximately 5 km long. We invest in fully integrated plants. In one location, we merge the sawmill production of timber with MDF and chipboard production. Innovative sawing technologies and synergy effects that arise through the link with the plant create significant synergies. The direct link with the railway network also guarantees environmentally-friendly transportation and supply structures.

Sustainability is more than a word at EGGER: wood is used in materials, from timber production in the sawmill to the production of wood-based materials. The use of recycled materials in EGGER products means that 1.73 million tonnes of CO₂ per year remain locked up in products as compared to burning them. Biogenic fuels that cannot be used in products are transformed into

The fully integrated plant saves **7,000** truck transports annually

heat and environmentally-friendly electricity in our own biomass power plant. In this way, we avoid approximately 1,487,000 tonnes of CO₂ emissions from fossil fuels per year.

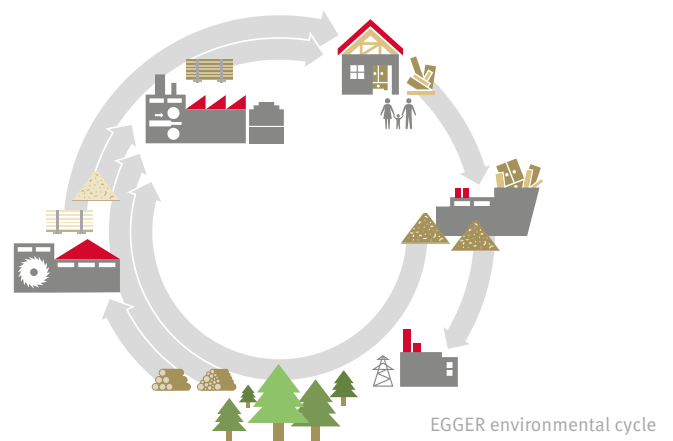

Always one step ahead thanks to the latest technology.

Highly innovative machines, such as **Wood-X, Goldeneye** and the **profile chipping line** with mobile profile mills, characterise the Brilon sawmill.

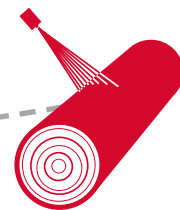

1. Log yard

The quality of the delivered log is checked via two short log sorting lines and a long log sorting line (3 to 20 m), measured via a calibrated procedure (incoming goods measurement), and finally debarked. The X-ray scanner **Wood-X** is used in the log

yard to scan and pregrade the logs individually by X-ray. This technology is employed in advance on the basis of certain sorting criteria to decide on quality and later use:

- Heartwood content
- Knot area ratio (KAR)
- Knot volume and knot gaps
- Type of knots, such as black knots or adnate knots
- Annual ring spacing
- Raw density and changes to the raw density such as rot
- Foreign substances such as stones and metals

2. Debarking and storage

The Wood-X scanner works with four fixed X-ray tubes, which create a 3D image of each individual log and represent the sorting criteria. The values identified dictate the respective sorting boxes. The best timber is cut from each log with the help of this data.

The logs are debarked and trimmed, and then temporarily stored on the five-hectare log yard, divided by the wood species spruce and pine.

80,000 m³
storage capacity

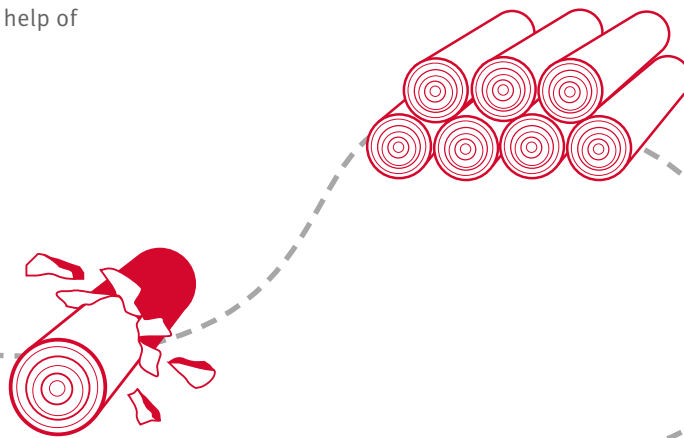

3. Saw line

Logs with a length specification from 3 to 5.4 m and a diameter from 12 to 65 cm can be cut with the flexible **profile chipping line** made by Linck. A model is milled after measuring and positioning the logs with the help of chipper blades. Mobile profile milling units define the dimension. All timber products are cut in the downstream double-wall circular saw device. An optional movable horizontal sawmill allows the cutting

of square and dimension lumber. The maximum feed rate of the device is 180 m/min, which leads to an average output per shift of 1,500 solid cubic metres. The green timber gets visually graded according

to the market and customer specific grading rules. The green timber packages or packs for the kiln chamber are put together in the in-line packaging facility.

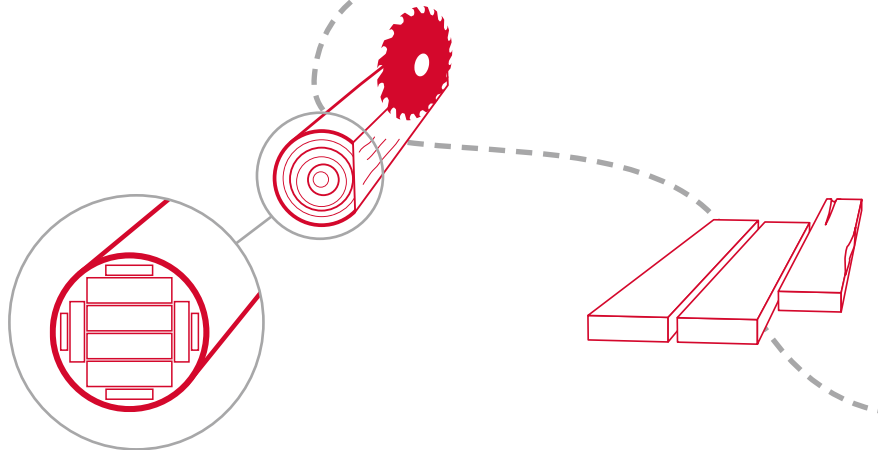

Goldeneye – We have the licence to X-ray.

4. Drying chambers

Twenty low temperature drying chambers and a progressive kiln with a total length of 110 metres offers an annual drying capacity of approximately 500,000 m³. The thermal energy for the drying process is generated by the plant's own biomass power plant.

All drying chambers are certified by North Rhine-Westphalia on the basis of the IPPC standard. The **IPPC process** is compulsory for international timber trade. It protects forest stock from the introduction of foreign wood pests. The final moisture of the products corresponds to existing standards and regulations. Kiln drying to a maximum moisture content of

maximum 20% is necessary for the professional use of timber in construction. This allows for sufficient protection from insects and fungi and also prevents excessive deformation of the wood. Customer-specific adjustment of wood moisture is also possible.

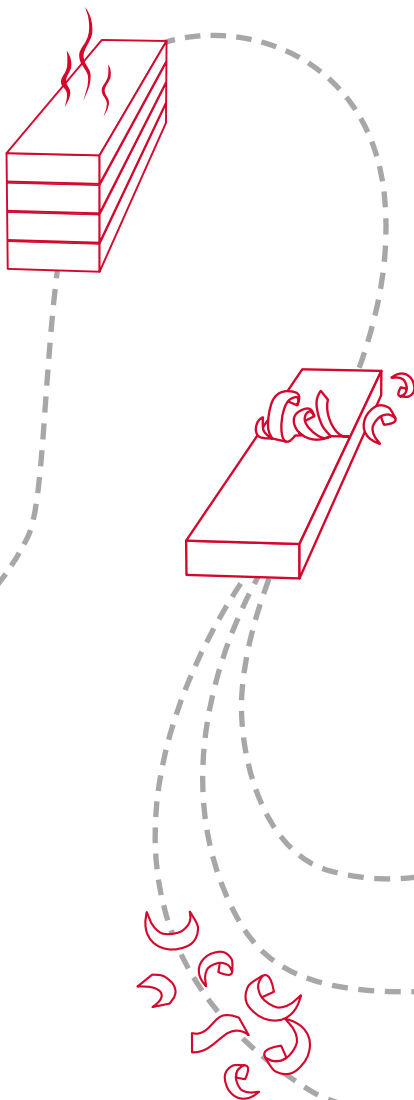

5. Planer line

The high-performance planing facility, with a maximum feed speed of 800 m/min, is versatile despite its high speed. In addition to profile cutters, the standard planer heads include planer heads that have the capacity to split the timber. The timber is machine-sorted using two different methods. The **Viscan** measures the oscillation frequency of the boards and calculates the elasticity module. With help of camera, laser and X ray technology, two goldeneyes scan not only the knot area ratio of the strength of the wood, but also the surface properties.

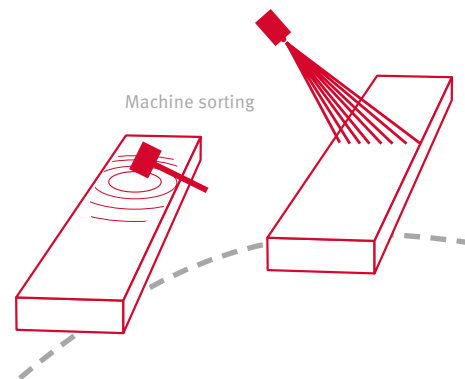

The scanner certificates give characteristics and the wood properties that are listed from this fulfil the criteria of MGP 12 (Australian stress rating) or C40 (strength class for load-bearing purposes according to EN 338) sorting. The high-performance sorting facility compiles the machined and/or visually sorted timber products from the planing line for subsequent bundling and packaging. The high-performance bundling makes up to 24 bundles per minute and is therefore Europe's fastest bundling machine.

6. Packaging and storage

The finished timber is stored in the 40,000 m² open storage area and in a 15,000 m² covered area. Transport can be organised from here to anywhere in the world via road, rail or container.

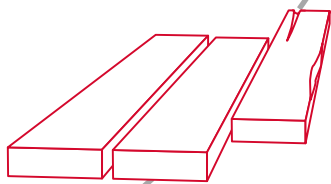
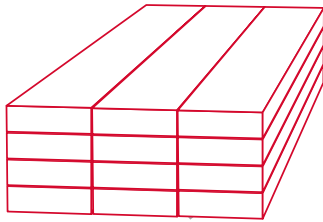

Visual sorting

Material residues, such as chips and sawdust, are transported from the sawmill via two 1.6 km conveyor belts for further use in the production of wood-based materials.

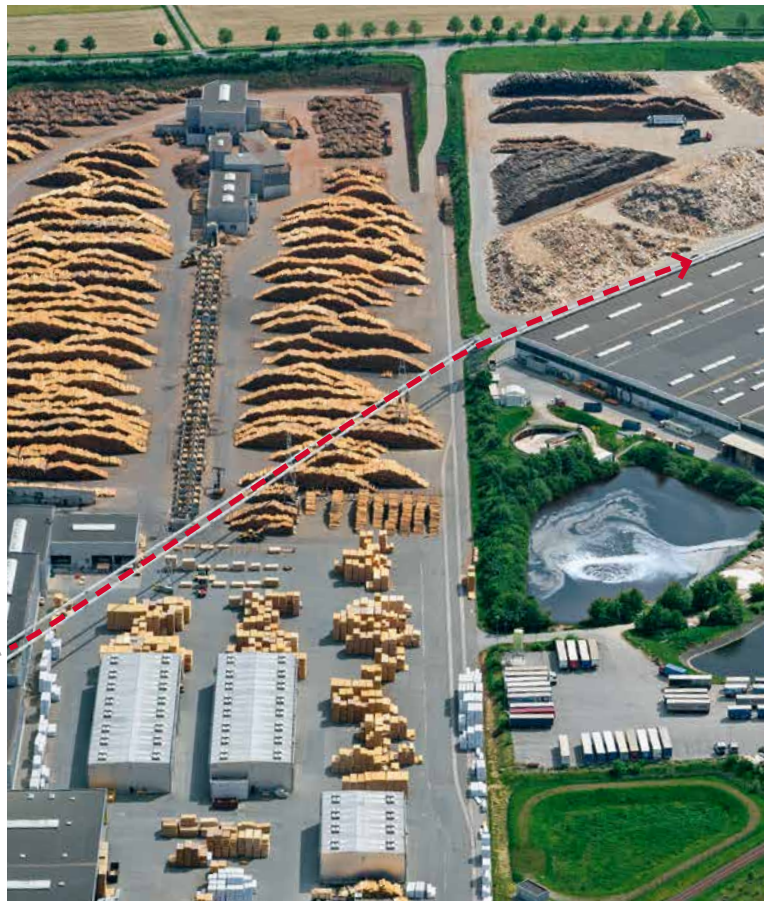
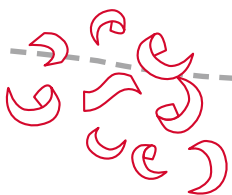



2 Application areas

We have the right board
and batten for your project.

EGGER timber is available in an extensive, tested and certified product range. The application areas include structural products for timber construction, the prefabricated homes industry, and timber wholesale trade, as well as semi-finished products for the processing industry and packaging materials.

Application areas for EGGER timber

1. Wood construction

Timber is used in timber frame construction primarily as solid structural timber. Timber products are also used as machine-sorted roof battens and counter battens for roofing, as substructures for facades and in interior applications.

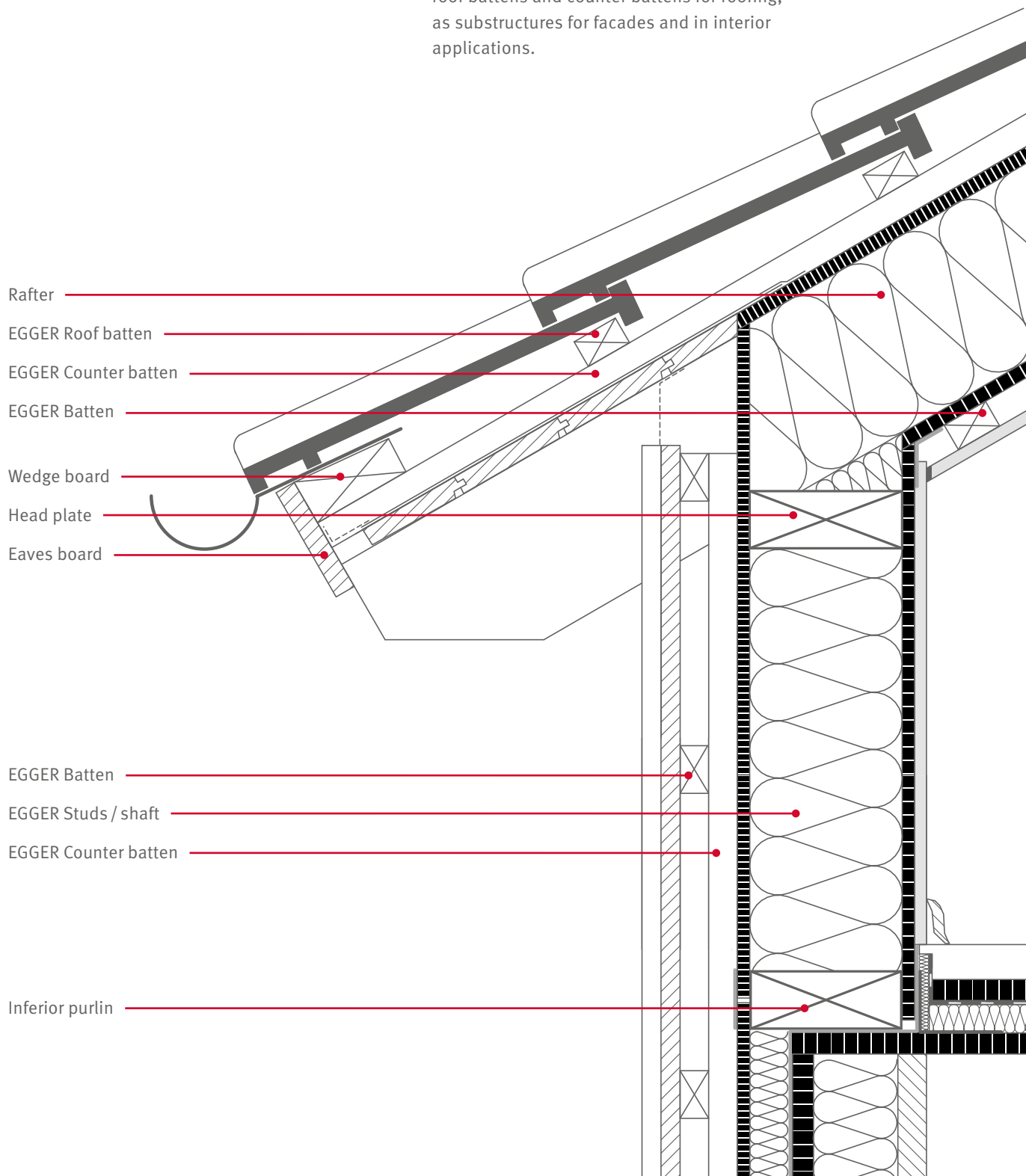

2. Industrial production

Timber products are used as semi-finished products in the Industry and Packaging sector. Industry uses the raw goods primarily for the production of value-added products such as glue-laminated post and beams, or finger jointed construction lumber or cross laminated timber (CLT). High quality and defined wood moisture ranges are required in this case. Sawfalling material according to the IPPC standard is processed in the packaging industry, for example for food pallets or cable drums.

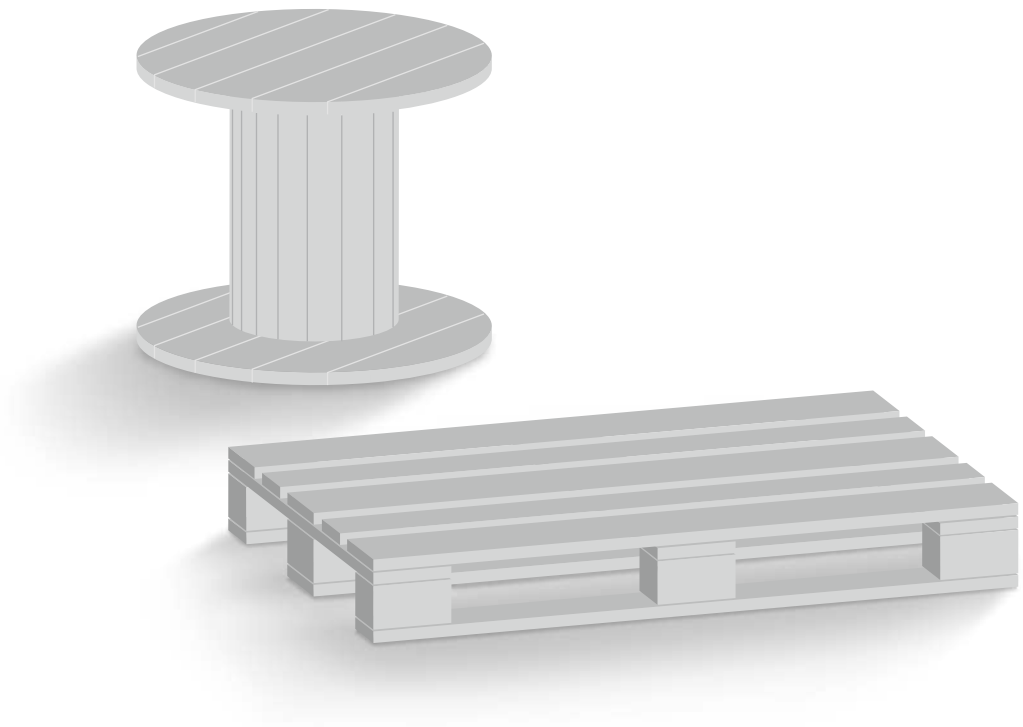



3

3 Sawmill products

We cut everything.

Long or short, broad or small dimensions.

From roof battens to solid structural timber. From squared timber to the profiled board. EGGER timber is available green, kiln dried or planed. Visual and machine grading according to visual requirements and strength complies with the highest requirements of our customers.



General information

EGGER timber is produced in the product groups “green”, “kiln dried”, and “planed”, by quality and size according to customer specific requirements.

Green timber dimensions

Delivery dimension	Minimum (mm)	Maximum (mm)
Length	2,500	5,400
Thickness	12	150
Width	60	325

Kiln dried timber dimensions

Delivery dimension	Minimum (mm)	Maximum (mm)
Length	1,800	5,400
Thickness	17	125
Width	30	325

Planed timber dimensions

Delivery dimension	Minimum (mm)	Maximum (mm)
Length	1,800	5,400
Thickness	19	120
Width	60	320

Product characteristics

Product group	Wood moisture (u)	Surface
Timber green	> 20 %	rough sawn
Timber kiln dried	≤ 20 %	rough sawn
Timber planed	10 – 18 %	planed / leveled

Product parameters

Standards and certificates

	Standard	Grading classes	Country	Product
Visually graded	DIN 4074-1 ÖNORM 4074-1	S10, (S7), (S13)	Germany Austria	Battens, squared timbers, solid structural timber, boards, planks
	EN 14081-1	C24, (C18), (C30)	Germany EU	Squared timbers, solid structural timber
	BS 4978	GS, SS, C16, C24	England	Battens, planks, squared timbers
	AS 2858	F-Grades	Australia	Studs, dimensions
	PS 20-10	No. 2+, No. 3, Standard, 2COM and 3 COM	USA	Studs, boards
Machine graded	EN 14081-1	C16M - C40M	Germany EU	Squared timbers, solid structural timber
	EN 14081-1	C24M - C27M	Germany	Roof batten
	EN 14081-1	L14 - L40	Germany EU	Raw goods laminated beams
	AS/NZS 1748.1	MGP 10, MGP 12	Australia	Studs, dimensions

Other standardised sorting types are possible upon request.

Wood-specific values

Property	Standard	Unit	Value
Fire behaviour	DIN EN 14081-1	–	d > 22 mm: D-s2, d0
Building materials class	DIN 4102-4	–	B2 – normal flammability
Thermal conductivity λ_R	EN 12523	W/(mK)	0.13
Diffusion resistance grid μ (dry cup/wet cup)	EN 12524	–	50/20
Specific thermal capacity c	EN 12524	J/(kgK)	1,600
Natural durability	EN 350-2	–	Spruce 4 Pine 3-4
Raw density ρ	EN 350-2	kg / m ³	Spruce 460 Pine 520

We are proud of our wood.



Squared timbers / planks / boards

Timber products are made according to the customer's requirements and are available green or kiln dried. Squares, planks and boards are available at regular intervals and are used as pallet material for packaging or as concrete shuttering boards.



Squares

Kiln dried (< 20%), rough sawn, ISPM 15, suitable for the construction sector, dry dimensions

Thickness (mm)	Width (mm)	Length (mm)	Application area
75 – 95	75 – 115	2,500 – 5,100	Packaging

Planks

Green goods, drying possible, rough sawn

Thickness (mm)	Width (mm)	Length (mm)	Application area
40 – 50	200 – 275	2,500 – 5,100	Building industry Raw boards Scaffold boards

Boards

Kiln dried (< 20%), rough sawn, ISPM 15, suitable for the construction sector, dry dimensions

Thickness (mm)	Width (mm)	Length (mm)	Application area
17 – 24	75 – 200	2,500 – 5,100	Building industry Packaging

Special lengths are possible upon agreement.



4 Handling

Boards mean the world to us.

And this is why particular attention is given to packaging and storage – whether battened, unbattened, dried or planed. Europe’s fastest batten bundling machine is used before the timber is packaged. In this way, the sawmill is also equipped for large orders.

Storage and packaging

Correct storage and packaging are essential for problem-free handling. Green timber is wrapped with plastic straps and sent battened or unbattened, depending on the customer's requirements. When needed, the goods are also secured when packaged. Dried or planed types are packed in mesh foil to protect them from the weather. The foil can be ordered either with the EGGER logo or in white.

The **bundling facility** means the sawmill is well equipped for large orders. As the fastest batten bundling facility in Europe, this system has a maximum output of 24 bundles per minute. Lengths of 1,8 to 5,4 metres and various bundle sizes are possible, where the maximum bundle size is 160 × 160 mm.

The following principles should be observed:

- Flat storage on uniformly high square timbers.
- If several pallets are stacked on top of each other then the squared timber should be aligned by height.
- When using a forklift for transport, the squared timber must be high enough to prevent damage.
- The packaging straps around the packages should be removed promptly in order to avoid compression stress in the package during storage in a warehouse.
- The timber should be properly protected from direct weather exposure.

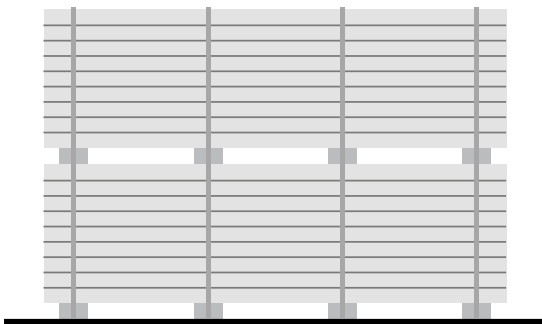

Disposal

Timber may be used in both material or energy recycling. Residues from construction sites as well as those from demolition projects should primarily be utilised materially. If this is not possible, they must be utilised for energy generation instead of dumping (waste material key according to European waste material catalogue: 170201/030105). Laminate that is not

treated with wood preservatives but in any case lacquered, laminated, or glued, can be assigned to the waste category A I according to the 1st Federal Emission Protection Ordinance. Wood-processing companies may thermally recycle wastewood of category A I in residential combustion facilities that do not require permits according to emission protection legislation.



Our battens
are the top.
Even when it
comes to storage
and packaging.



5 **Quality and service**

We have a trained
eye for timber.

And thanks to this trained eye we make the best of the raw material wood. Our timber fulfils all domestic and international requirements in all application areas. Sustainable forestry has the highest priority for us. All relevant information is available on the following pages. If you have any further questions, please do not hesitate to contact us. We are always happy to assist.

We are well stacked.
With wood and know-
how, of course. And
we're happy to share.



Quality

The EGGER sawmill in Brilon consistently bases its product groups on the needs of its customers and country- and market-specific requirements. EGGER timber is sold all over the world, and used in a variety of applications. Our timber fulfils all domestic and international requirements in all application areas. We work with accredited testing institutes in the relevant markets across the world in order to ensure country-specific requirements are met. Continuous, plant-based monitoring guarantees the constant high quality of products.

The EGGER sawmill in Brilon processes softwood, mainly spruce, from sustainable forestry operations in North Rhine-Westphalia, Hessen and Lower Saxony. The responsible use of wood and a keen ecological awareness are a matter of course for EGGER.

As a fully integrated plant, all types offered by our forestry suppliers can be accepted. Thus any waste wood and thinnings produced by the forestry management programme can be utilised. Exemplary and **sustainable forestry** has the highest priority at EGGER.

Environmental product declarations

The sustainability and environmental compatibility of our timber products has been tested and verified by independent institutes. All relevant information is published in EPDs (environmental product declaration, according to ISO 14025).



All of our certificates and our EPDs you can find in our download area.

www.egger.com/downloads

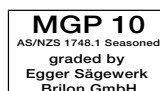

→ **What do we have to say on the topic of the environment?**

Find answers and insights in our environment and sustainability brochure.

www.egger.com/timber

Technical Support

buildingproducts@egger.com



Do you want to know more?
Simply scan here and get detailed information.

EGGER Sägewerk Brilon GmbH

Im Kissen 19

59929 Brilon

Germany